

EVENO
Les éléments de votre Confort

Les STORES VERTICAUX
extérieurs zippés

Ambio Zip & Stylbio Zip



Ambio Zip - Store Vertical Extérieur

Système ZIP pour le maintien de la toile dans les coulisses même par temps venteux



Ambio Zip solaire

Cas de **pose** :



Cas 1 et 2

Sous linteau
Enroulement extérieur



Cas 3

Sous linteau
Enroulement intérieur



Cas 2

En applique
Enroulement extérieur

Également disponible :

Nouvelle génération

Ecosystème de motorisation solaire avec télécommandes



Voir pages **LES COMPLÉMENTS**

L'inconfort d'été

Store haute protection solaire

Exemple toile :

Naturel
7605-51187



Technologie Smart Yarn

Technologies Canatex & SmartYarn brevetées par Serge Ferrari® avec utilisation de 1% de chanvre donnant un aspect mat et naturel au tissage.



Caractéristiques techniques

FORME du caisson

Carré 115x115

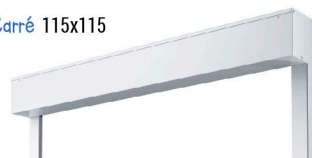

BARRE DE CHARGE

ferme caisson

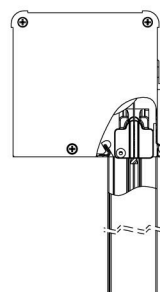

COULISSES

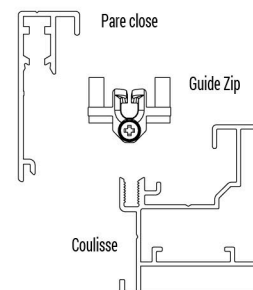
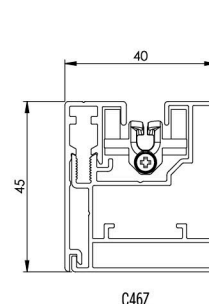

COUPES du caisson

Pose en applique
Enroulement extérieur
Perçage de face
Cas 2

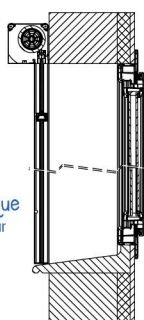

Pose sous linteau
Enroulement extérieur
Perçage tableau
Cas 1
Perçage de face
Cas 2

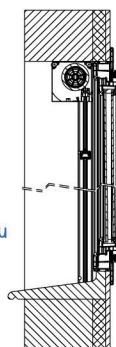

Pose sous linteau
Enroulement intérieur
Perçage tableau
Cas 3

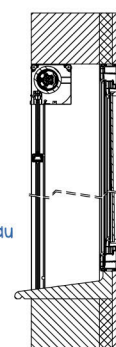

Pose sous linteau
Enroulement extérieur
Perçage tableau
Cas 1

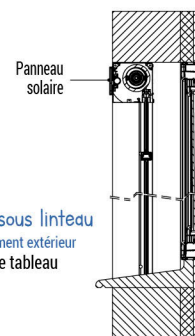

LIMITES D'UTILISATION du store

Hauteur caisson compris	800	900	1000	1100	1200	1300	1400	1500	1600	1700	1800	1900	2000	2100	2200	2300	2400	2500	2600	2700	2800	2900	3000	
850																								
950																								
1050																								
1150																								
1250																								
1350																								
1450																								
1550																								
1650																								
1750																								
1850																								
1950																								
2050																								
2150																								
2250																								
2350																								
2450																								
2550																								
2650																								
2750																								

Ambio Zip - Ambio Zip Solaire

OPTION Solaire

Panneau solaire déporté

Dans le cas de pose sous dalle ou de mauvaise exposition. Longueur 3 m.



Voir pages HORIZON

Chargeur de batterie

Longueur 3 m, temps de charge 1h40. un chargeur par logement.



TYPES ET LIMITES MINI des manœuvres

(Valeur en dos de coulisses)

Fabricant	Type de manœuvre	Protocole	Mini de manœuvre
Stella Advanced Technology	Zigbee Z300	Zigbee	550
	Néosol	868 MHz	570
	Filaire		550

CLASSEMENT AU VENT

Hauteur sous coffre (mm)	2750	Largeur dos de coulisse (mm)
		3000
		Classe 5

Voir pages LES COMPLÉMENTS

Commandes individuelles et générales

En savoir plus sur legrand®



Stylbio Zip - Store Vertical Extérieur

Système ZIP pour le maintien de la toile dans les coulisses même par temps venteux



Stylbio Zip solaire

Cas de **pose** :



Cas 1 et 2

Sous linteau
Enroulement extérieur



Cas 3

Sous linteau
Enroulement intérieur



Cas 2

En applique
Enroulement extérieur



Sur pergola

Également disponible :

Nouvelle génération

Ecosystème de motorisation solaire avec télécommandes



Voir pages **LES COMPLÉMENTS**

L'inconfort d'été

Store haute protection solaire

Exemple toile :

Otarie
7605-51192

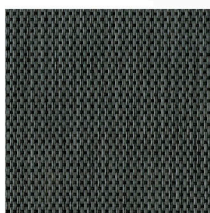

Technologie Smart Yarn

Technologies Canatex & SmartYarn brevetées par Serge Ferrari® avec utilisation de 1% de chanvre donnant un aspect mat et naturel au tissage.





Caractéristiques techniques

FORME du caisson



Carré 95x95 - 125x120
125x120 obligatoire si :
- LDC ≥ 3000 ou HCC ≥ 3000

Neosol uniquement en caisson de 125

BARRE DE CHARGE ferme caisson

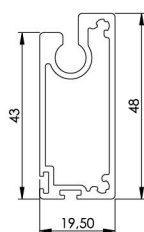

COULISSES

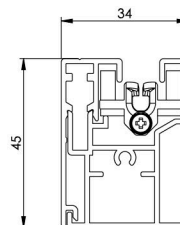

C45Z

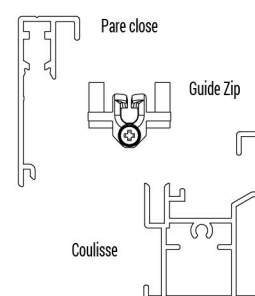

COUPES du caisson

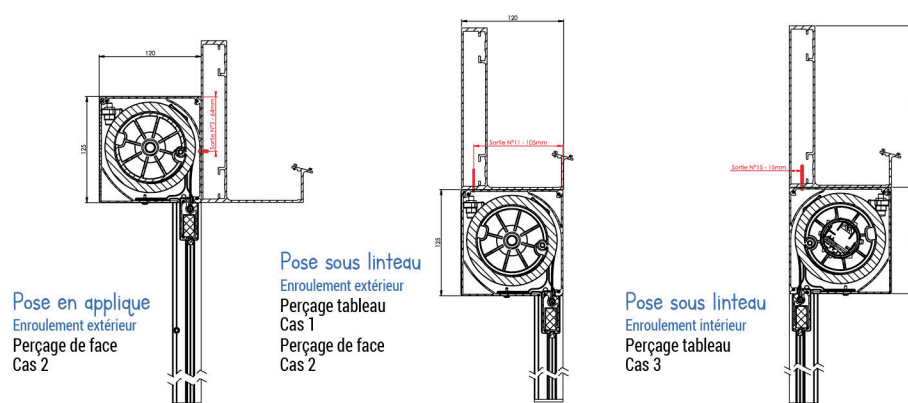

Pose en applique
Enroulement extérieur
Perçage de face
Cas 2

Pose sous linteau
Enroulement extérieur
Perçage tableau
Cas 1
Perçage de face
Cas 2

Pose sous linteau
Enroulement intérieur
Perçage tableau
Cas 3

LIMITES D'UTILISATION du store

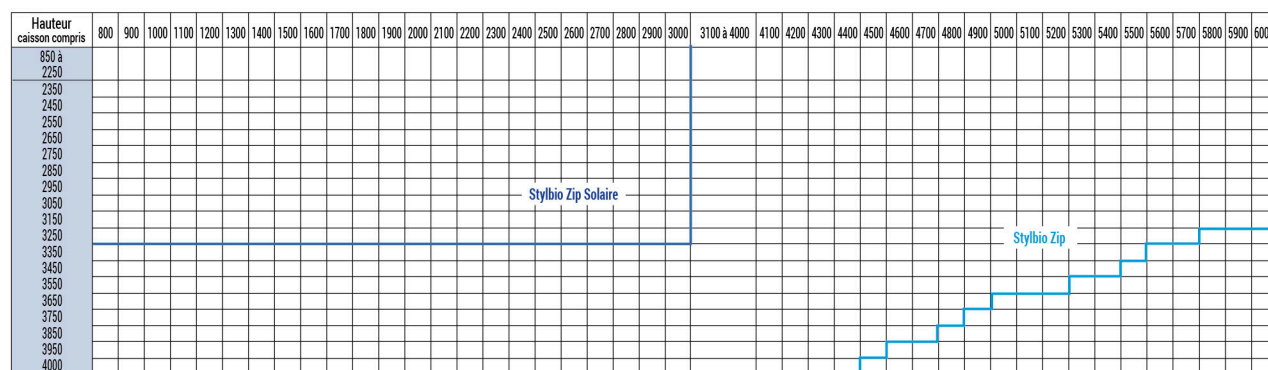

TYPES ET LIMITES MINI des manœuvres

(Valeur en dos de coulisses)

Fabricant	Type de manœuvre	Protocole	Mini de manœuvre
Stella Advanced Technology	Zigbee Z300	Zigbee	550
	Néosol	868 MHz	570
Somfy	Maestria	IO	749
	Filaire		550

CLASSEMENT AU VENT

Hauteur sous coffre (mm)	Mini de largeur dos de coulisse (mm)		
	3000	5000	6000
3000	Classe 5	Classe 4	Classe 3
4000	Classe 4	Classe 4	Classe 3

OPTION Solaire

Panneau solaire déporté

Dans le cas de pose sous dalle ou de mauvaise exposition.
Longueur 3 m.



Voir pages HORIZON

Chargeur de batterie

Longueur 3 m, temps de charge 1h40.
un chargeur par logement.



Voir pages LES COMPLÉMENTS

Commandes individuelles et générales
En savoir plus sur **legrand**

Nuancier Stylbio Zip et Ambio Zip

Store toile Veozip

Délai **4 semaines**

				
Ombre 7605-51194	Blanc Givre 7605-51184	Edelweiss 7605-51185	Cumulus 7605-51186	Naturel 7605-51187
				
Macadamia 7605-51188	Mistral 7605-51189	Toundra 7605-51190	Terre de Lune 7605-51191	Otarie 7605-51192
				
Oursin 7605-51193	Volcan 7605-51195	Santal 7605-51196	Poivre Gris 7605-51197	Noir Graphite 7605-51198

Coloris encadrement Coulisses, Barre de charge, Caisson

Satinés



Texturés



CONFIGURATION consultez le site de services Eveno :

